



STEP® Marine

Warmfloor Installation Manual



Electric Radiant Floor Heating System

Contents

INSTALLATION GUIDELINES	3
IMPORTANT INSTALLATION GUIDELINES.....	3
STEP® MARINE HEATING SYSTEM.....	3
BEFORE STARTING	4
DESIGN AND CALCULATIONS.....	4
FLOOR SURFACE AND INSULATION.....	4
REQUIRED TOOLS	4
DESIGN AND CALCULATION	5
HEATING NEEDS	5
FLOOR WARMING.....	5
PRIMARY HEATING	5
LAYOUT AND DESIGN	6
RECOMMENDED SPACING.....	6
ROOM LAYOUT AND ELEMENT STRIPS	6
ELEMENT TYPE AND WATTAGE	7
ELEMENT LENGTH AND WATTAGE PER POWER SUPPLY	7
WIRE GAUGE AND TERMINAL BLOCK USAGE.....	8
CONTROL AND THERMOSTAT OPTIONS	9
24 VOLTS THERMOSTAT	9
ELECTRICAL GUIDLINES	10
Electric Radiant Heating Equipment Operating at 30 Volts or Less.....	10
INSTALLATION.....	12
STEP 1 - POSITIONING THE ELEMENTS	12
STEP 2 - CONNECTING THE WIRES TO THE ELEMENT	14
STEP 3 – ROUTING THE WIRES	15
WIRING OPTIONS	16
FAIL SAFE WIRING	17
STEP 4 – CONNECTING THE ELEMENTS TO THE POWER SUPPLY.....	18
STEP 5 – CONNECTING THE POWER SUPPLY AND CONTROLS	19
WIRING DIAGRAM FOR THE PCB INTERFACE BOARD	20
WIRING DIAGRAM FOR THE PCB REGULATOR BOARD	21
STEP 6 – LEVELING AND COVERING THE FLOOR.....	22
WARRANTY REGISTRATION AND COVERAGE	23
LIMITED WARRANTY:.....	23
WARRANTY REGISTRATION CARD.....	24
CHECK LIST	25
TROUBLESHOOTING	26

INSTALLATION GUIDELINES

IMPORTANT INSTALLATION GUIDELINES

- Choose qualified personnel who are familiar with the STEP® heating system.
- This is an electric heating system and requires trained personnel in the National Electrical Code that understands the importance of preventing mistakes that can cause an electrical fire.
- The installation shall be made in accordance with local codes, ordinances, trade practices, and manufacturers' instructions.
- Make sure that all materials used are approved for the specific application and have no adverse compatibility with the heating elements.
- Use only components recommended by the manufacturer.
- Read and follow the installation instructions to assure having the best satisfaction for a comfortable and energy efficient heating system.

STEP® MARINE HEATING SYSTEM

- STEP® Marine is a flat, flexible and thin heating element.
- The heating element can be cut to length at the jobsite.
- The element can be stapled/nailed without affecting the conductivity (do not penetrate the two conductors on each side).
- The element can easily be bent 90 degrees to fit any contour.
- The element is strong and has no failure rate during installation.
- STEP® Marine can be used under almost any flooring including tile, stone, wood, laminate, resilient and carpet.
- The system is ideal for both renovation and new construction.
- No room is too small or too large to be heated with STEP® Marine.
- Because the product is thin, 3/64" (1.2mm), it can be installed without changing the height of molding, doors or cabinets.
- The system is designed to simplify the individual control of each room.
- STEP® Marine has the ability to self-regulate - as the material gets warmer, less electricity passes through the polymer - therefore it is extremely energy-efficient.
- The element acts on its whole surface as a sensor and cannot overheat.
- This unique Nano technology has been around for over 30 years.
- This heating system is very versatile and can be used for residential, commercial, industrial and marine applications. From taking away the chill of cold floors to keeping free of ice and snow driveways, ship decks and more.
- If it needs heating STEP® Marine has the solution.

BEFORE STARTING

DESIGN AND CALCULATIONS

- The installation shall be calculated and a layout made to determine the materials required.
- The more specific the layout the easier will be the installation. Indicate for each area:
 - Exact room measurements and fixed fittings.
 - Placement and number of strips of elements.
 - Length and wattage per element strip.
 - Location of power source, including control and power supply(s).
 - If required, location of electrical box and terminal block(s).
 - Wire size and length according to load and distance to the power source.
 - Size of power supply and load distribution on the interface board.

FLOOR SURFACE AND INSULATION

- For energy efficiency, thermal insulation is required under the heating elements. Remember that hot goes to cold, equally in all directions.
- The heating elements can be installed on any dry, clean, non-conductive, and structurally sound surface.
- Floor temperature should be at least 65°F (18°C) when installing the elements.

REQUIRED TOOLS

- STEP® crimp tool
- Utility knife or scissors
- Wire stripper
- Screw driver
- Multi-meter (clamp meter preferred)

DESIGN AND CALCULATION

HEATING NEEDS

Decide on the application of the floor heating system before starting design and calculations. The calculations should take into considerations:

- Heating required; primary heat, complementary heat, or floor warming.
- Outside average temperature, insulation values and room size.
- Additions and conservatories may need to be calculated according to usage and construction.

FLOOR WARMING

Floor warming systems take the chill out of cold floors, but are not designed to be the primary heat source. Typically a floor warming system is installed in the bathroom and underneath tiles in the kitchen, hallway or other areas where you want the comfort of under floor heating. When used as a complementary heat source it shall provide a gentle and even under floor heating experience in addition to the existing heating system in the house.

- For floor warming evaluate the needs for each area: room type; available open floor space and floor covering.
- Bathrooms may require more heat and this can be achieved by selecting heating elements with a higher wattage or placing elements under tubs or shower pans, in walls or behind mirrors.
- Use a floor sensor to avoid competing thermostats from other heat sources.

PRIMARY HEATING

For primary heating a heat loss calculation is required. This can be done per room or for the whole house. STEP® Marine provides services for project specific heat loss calculations.

- Perform a heat loss calculation to identify the wattage needed to heat the area to the required temperature in your location.
- You will need to know the type of construction, the measurements and insulation values of the floor, walls (including windows and doors) and ceiling.
- Design the spacing between the elements and/or use an element type with higher wattage to get the necessary wattage.

NOTE: Floor surface temperature should not exceed 85°F (29°C)

DESIGN AND CALCULATION

LAYOUT AND DESIGN

RECOMMENDED SPACING

Maximum recommended spacing between strips of elements:

Ceramic tile, natural stone, resilient	2 - 3 inches	5 - 7.5 cm
Hardwood, laminate	2 - 5 inches	5 - 13 cm
Carpet	2 - 8 inches	5 - 20 cm

Where the heating needs are less than 3.5 W/sqft. (38 W/m²), plan the distribution so that the strips of elements do not exceed the recommended spacing to avoid uneven temperatures (i.e., cold spots between the strips of elements). Or, use an element with less wattage.

ROOM LAYOUT AND ELEMENT STRIPS

Measure the room(s) and create a drawing of the area to be heated. Make sure to draw in any fixed fixtures and other areas where heating is not to be installed.

Position heating elements, power supply and thermostat



Position the elements in the most convenient direction to have as few strips as possible taking in consideration where the wires will be connected.

- 1) Make sure to place elements close, in front of the vanity, shower and toilette.
- 2) In narrow areas where the distance between the strips is more than the recommended spacing consider:
 - a. changing direction of the elements
 - b. adding more distance between the wall and the first element
 - c. using 9" wide elements
- 3) Indicate number and length of each strip.
- 4) Position the thermostat on an interior wall away from windows, doors and other areas with draft.
- 5) The power supply must be installed in a well-ventilated area in accordance with Article 450 of the National Electric Code. Provide sufficient clearance for free flow of air to allow adequate cooling. Keep delicate and flammable materials away from the power supply enclosure.

NOTE: Make sure to always place element strips perpendicular to hardwood and engineered floors.

DESIGN AND CALCULATION

ELEMENT TYPE AND WATTAGE

The default heating element for floor warming projects and most primary heating projects is MEP-30-36W. Installing heating elements with substantially higher wattage than needed will make the system more reliant on a thermostat and thereby decrease energy efficiency.

Choose the appropriate heating element according to the heating needs, available open floor space to be heated and floor covering.

ELEMENT DATA at 24 VOLTS @ 68°F					INSTALLATION DATA						
Element Type		Ohms /ft.	Linear W/ft.	Density W/sqft.	Max. length @ 450W feet	Element spacing and wattage per sqft.					
Width	Model					2"	3"	4"	5"	8"	12"
9"	MEP-23-36W	52	11.0	14.6	41	12.4	11.7	11.0	10.2	8.8	7.3
12"	MEP-30-36W	52	11.0	11.0	41	9.4	8.8	8.3	7.7	6.6	5.5
12"	MEP-30-29W	64	9.0	9.0	50	7.7	7.2	6.8	6.3	5.4	4.5

Table: Element type and wattage

ELEMENT LENGTH AND WATTAGE PER POWER SUPPLY

The EPI-LX-R power supply series consist of one to three 500 watts circuits.

Designed wattage is 90% or 450 watts.

- 1) Do not exceed the maximum length @ 450W for the selected element in table "Element type and wattage"
- 2) Combine element strips from the layout to optimize distribution for each 450 watt circuit in the power supply.

POWER SUPPLY	DIMENSIONS			PRIMARY CIRCUIT BREAKER			SECONDARY CIRCUIT BREAKER
Transformer Type	Height (inch)	Width (inch)	Depth (inch)	120 VAC	208 VAC	230 VAC	24 VAC
EPI-LX-R-250W	7.4	6.9	3.5	5A		2.5A	1 x 15A
EPI-LX-R-500W	14.4	6.9	3.5	10A	5A	5A	1 x 25A
EPI-LX-R-1000W	22.4	6.9	3.5	15A	10A	10A	2 x 25A
EPI-LX-R-1500W	28.4	6.9	3.5	20A	15A	15A	3 x 25A

DESIGN AND CALCULATION

WIRE GAUGE AND TERMINAL BLOCK USAGE

Minimize voltage drop by planning the wire runs as short as possible. Use larger wire gauge for more power output.

Refer to the following chart for maximum secondary wire length, both wires included, per circuit in feet.

Power Watts	Wire Gauge and Wire Length (ft.)					
	14 AWG	12 AWG	10 AWG	8 AWG	6 AWG	4 AWG
60 VA	40	63	100	159	252	401
90 VA	27	42	67	106	168	268
120 VA	20	32	50	80	126	201
150 VA	16	26	40	64	101	161
180 VA	14	21	34	53	84	134
210 VA	12	18	29	46	72	115
240 VA	10	16	25	40	63	101
270 VA	9	14	23	36	56	90
300 VA	8	13	20	32	51	81
330 VA	8	12	19	29	46	73
360 VA	7	11	17	27	42	67
390 VA	7	10	16	25	39	62
420 VA	6	9	15	23	36	58
450 VA	6	9	14	22	34	54

To avoid increasing the height on the floor, use wires 14 AWG or 12 AWG. The maximum wire gauge on the connectors to the elements is 10 AWG.

If the power supplies are not close to the elements, instead of using larger wire size in the floor, or running too many or too long wires across the room, the elements can be connected to terminal blocks.

Keep each terminal block to maximum 450W and then calculate the appropriate wire size used to run to the power supply.

Refer to Wire Gauge and Length Calculator on www.warmfloor.com.

DESIGN AND CALCULATION

CONTROL AND THERMOSTAT OPTIONS

The STEP® Marine heating elements are self-regulating and therefore act as a sensor over the whole floor surface. Although the heating system does not require a control unit, except for an on/off switch, it is highly recommended to install a thermostat.

To ensure long life and maximum efficiency, use only recommended controls for the EPI-LX-R power supply series and DC Controllers.

24 VOLTS THERMOSTAT

The STEP® Touch thermostat can be used in conjunction with all the EPI-LX-R power supply series and the DC Controllers

- Install the thermostat on an interior wall and away from the sun rays and drafts.
- Measure the distance from the power supply to the thermostat to identify the length of the thermostat wire.

The low-voltage (24V) thermostat is connected to the power supply using a 3-conductor cable and can control up to 20 power supplies or 20 DC Controllers.

The thermostats have four settings:

- Pos.1 °C or °F: ▶ displays Celsius or Fahrenheit
- Pos.2 or DIM: ▶ display is lit or dimmed
- Pos.3 or EXT: ▶ displays the ambient or floor temperature when using an external temperature sensor.
- Pos.4 or SM: ▶ interior or snowmelt with remote external temperature sensor

The STEP® Touch thermostat collects temperature information every 1.5 second for 10 minutes before deciding to add or reduce heat. This cycle is repeated endlessly.

When the settings are done the thermostat is operated by two touch buttons only; up or down or press both buttons simultaneously to switch the heating off.

External Sensor

When installing complementary heating or floor warming use the external sensor EPI-LX-TS to avoid the thermostat from competing with thermostats from other heat sources. The sensor is also used when sensing the floor temperature is more important than the ambient temperature. The external sensor is installed in the floor and should not touch the elements.

ELECTRICAL GUIDLINES

Electric Radiant Heating Equipment Operating at 30 Volts or Less

General

1. **Scope.** This installation instruction covers electric equipment and associated components operating at 30 volts or less for indoor and outdoor use. For the purpose of this manual heating equipment shall include heating elements, unit heaters and power supplies.

2. **Definition.**
Heating Systems Operating at 24 Volts. A complete heating system consisting of components such as low-voltage isolating power supplies and heating elements, including associated components that are all identified for the use. The output circuits of the power supply shall be rated for not more than 25 amperes and operate at 30 volts or less under all load conditions (SELV – Safety Extra Low Voltage).
Where the supply (primary) voltage is 30VDC or less DC controllers may be used. (No transformer)

3. **Listing Required.** Heating systems operating at 24 volts shall comply with (A) and (B).
 - (A) **Listed System.** Heating systems operating at 30 volts or less shall be listed as a complete system. The heating elements, power supply and fittings shall be listed for the use as part of the same identified heating system.

 - (B) **Assembly of Listed Parts.** The listed system and approved system components shall be installed in accordance with the manufacturer's instructions.

4. **Specific Location Requirements.**
Floors, Walls, Ceilings and Roofs.
 - (A) Extension wires (non-heating leads) from the heating elements can be routed on the subfloor to the wall provided they do not directly touch and cross one another in the floor.

 - (B) Conductors extended through a wall, ceiling and roof shall be in accordance with NEC Chapter 3. Wires shall be run in conduits through building structure. Exposed wires should be organized in a raceway or similar.

5. **Secondary Circuits.**
 - (A) **Grounding.** Secondary circuits shall not be grounded.

 - (B) **Isolation.** The secondary circuit shall be insulated from the branch circuit by an isolating transformer if the supply is line voltage.

ELECTRICAL GUIDELINES

6. Provisions.

- (A) **Electric Radiant Heating Panels and Heating Panel Sets.** Installation shall be made in accordance with NEC 424.90 through 424.99 with the following exceptions on 424.93 (B) (3) and 424.99 (C) (5) described in (a) and (b) respectively:
- a. **PTC Polymer Heating Panel Sets.** Nailing or stapling of PTC polymer heating panel sets shall be done through the polymer material but at least 6mm (1/4 Inch) from the bus conductors. Nails, staples or other fasteners shall not penetrate the current-carrying bus conductors.
 - b. **Fault Protection.** A device to open all ungrounded conductors supplying the heating panel sets, provided by the manufacturer shall function when short circuit occurs and/or the current is limited by a protective device.
- (B) **Fixed Exterior Electric Deicing and Snow-Melting Equipment.** Installation shall be made in accordance with NEC Article 426 with the exceptions of grounding and ground-fault protection requirements described under 426.22, 426.27 and 426.28. Secondary circuit shall not be grounded according to 5 (A).

INSTALLATION

STEP 1 - POSITIONING THE ELEMENTS

NOTE: The elements are held down to the subfloor with cement based mortar, latex modified thin-set, staples, or approved tape. Do not use duct tapes, adhesives or premix products, unless they are approved by the manufacturer to be compatible with the heating elements.

- The heating element comes in a roll. Cut the element with a pair of scissors to the desired length. The maximum load per strip of element is 450 watts. Refer to Design and Calculation.
- The voltage drop through a long strip of element can be reduced by utilizing the double terminals on the power supply; i.e. make two elements each 225W. E.g. for element EP-30-36W, the length would be 20 feet. The length can be extended to 40 feet by connecting both ends of the element strip. Refer to Fail Safe Wiring.
- It is important to follow the layout and worksheets provided with the heating system. Should changes be made, it is important to recalculate the element length and load distribution on the power supply.
- The elements should be placed in open spaces and not underneath fixed fittings; such as bookshelves, cupboards, cabinets, etc.
- Minimum distance between elements and from plumbing fixtures is 2 inches (5 cm).
- Position elements in critical places, e.g., in front of the vanity (including toe-kick), the tub or shower and the toilet bowl.
- Choose where the wires will be connected and leave adequate spacing to route them.

Radiant Heating Installation Example:



INSTALLATION

- The extension wires can be connected on the floor, up the wall under the baseboard, or in raised foundation, under the subfloor.

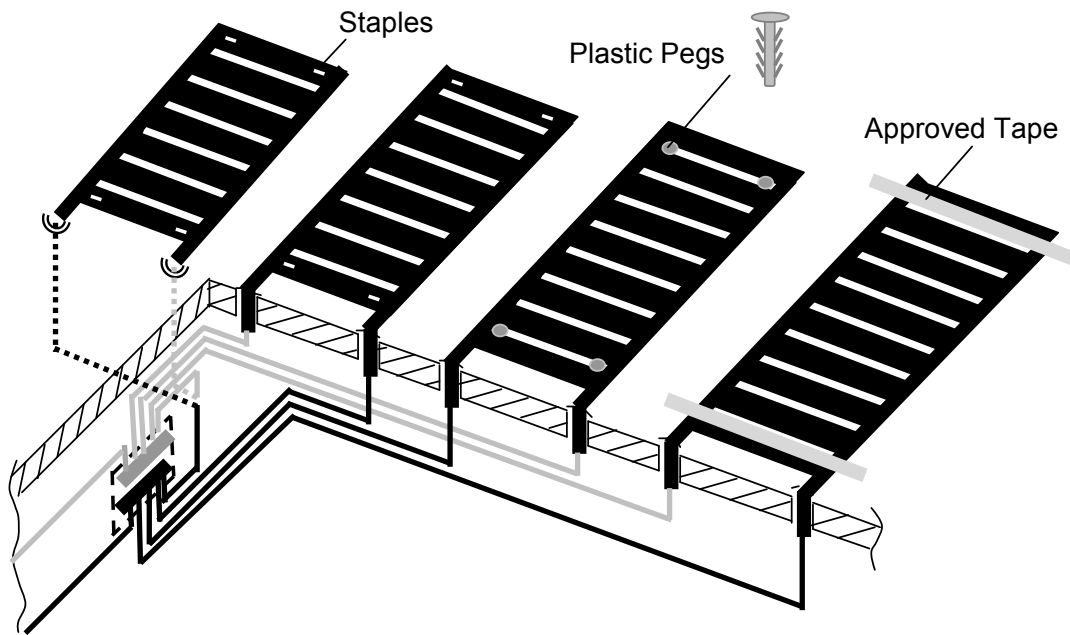

- Stretch the element in position. The elements must lay flat with no air gap.
- Anchor the elements to the subfloor using staples, plastic pegs or approved tape, secure on one end, stretch, hold, and then secure the other end,
- When securing the elements onto the floor, definitely avoid the bus braids on each side of the element.
- Connect the wires to the elements.

INSTALLATION

STEP 2 - CONNECTING THE WIRES TO THE ELEMENT

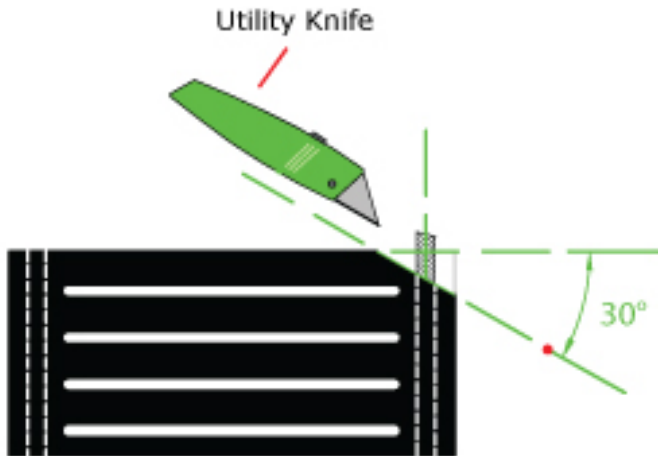

- **Expose the bus braids** by making an angled score in the plastic, front and back and along the bus braid above the score, with a utility knife. Bend the element where the cuts are made and pull off the corners to remove the surplus of plastic. **Make sure that the bus braid is not cut or damaged.** Should this occur re-cut the element and re-strip the bus braid. Repeat on the other side.

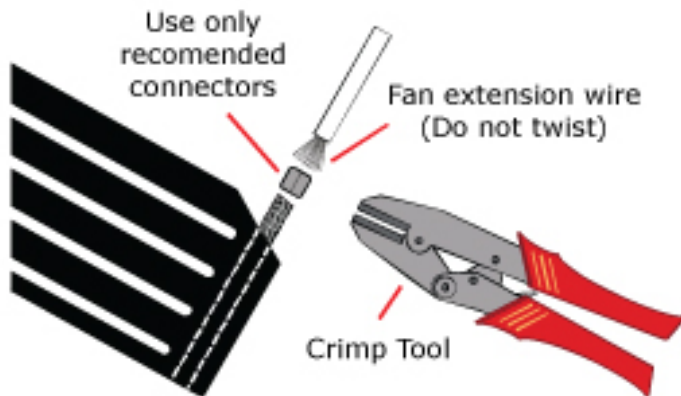

- **Connect the bus braid to an extension wire**, (PVC insulated, stranded tinned copper wire, 105°C, 300V). Refer to Wire Gauge chart. Crimp the joint using the recommended tinned copper connectors and crimp tool. Using components not recommended by the manufacturer will void the warranty.

IMPORTANT: Check that connections are secure.

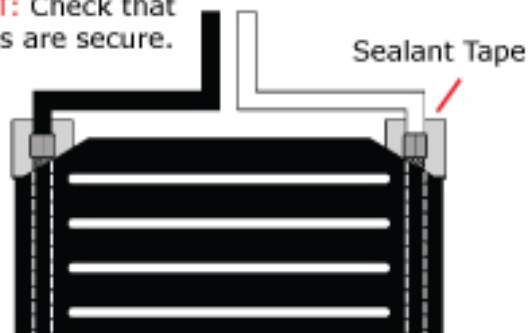

- **To differentiate the polarities supplied to the element**, use two different wire colors (e.g., black and white) and number them for future reference. Insulate the connections using the recommended sealant tape. Fold tape and press together overlapping element, connector and wire to form a flat and smooth splice.

INSTALLATION

STEP 3 – ROUTING THE WIRES

IMPORTANT: The installation shall be made in accordance to local codes and ordinances. Codes may require special wiring and/or a conduit (plastic or metal) in the walls.

- Plan circuit supply from main panel to on/off switch, control, power supply, terminal block (if needed), and heating elements. Refer to Wiring Diagram, Power Supply Capacity, and Wire Size.
- Power Supply shall be placed vertical on a wall, in the ceiling, under the floor or in a closet, according to NEC code in such a way that heat is dissipated effectively. Make sure that vibration is not transmitted through the wall or structure.

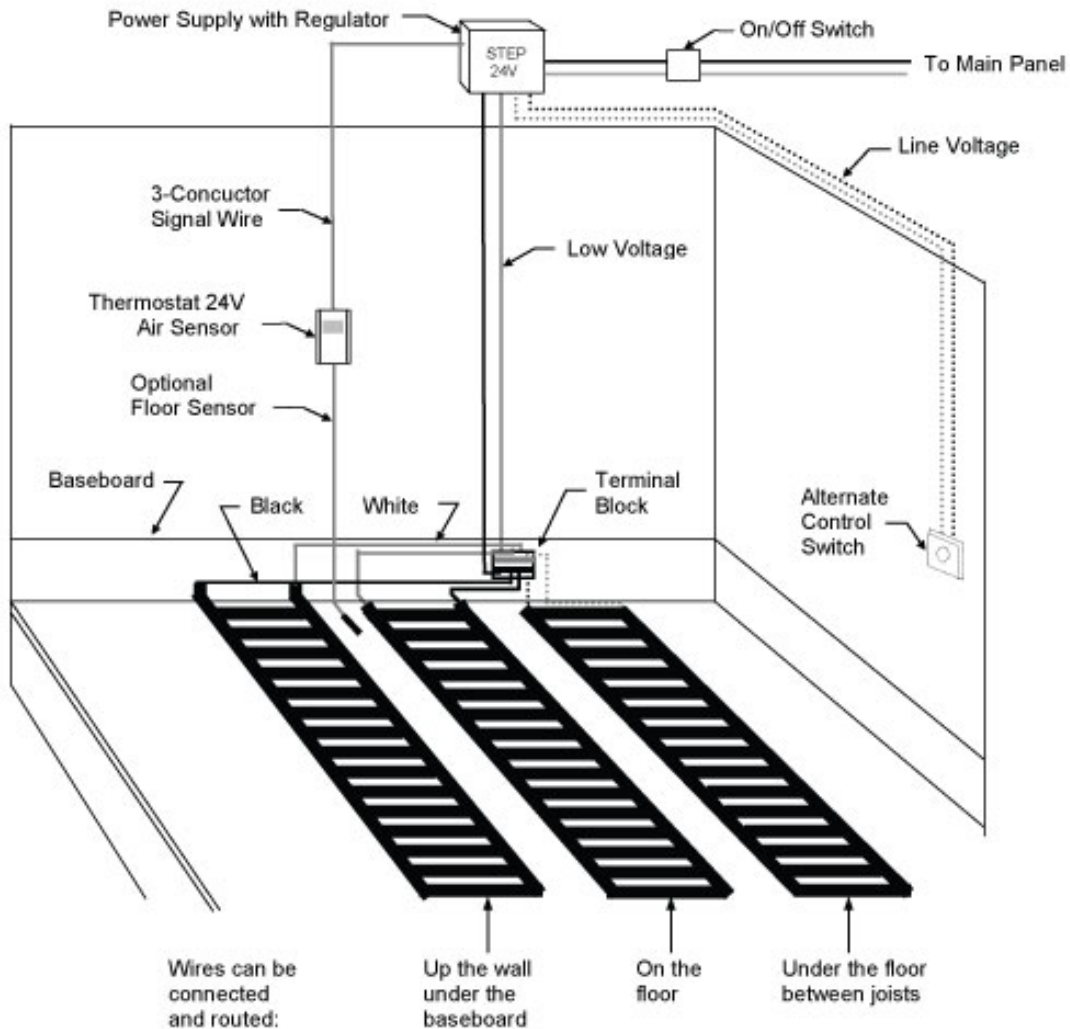

INSTALLATION

WIRING OPTIONS

IMPORTANT: Refer to Wire Gauge Chart to minimize voltage drop.

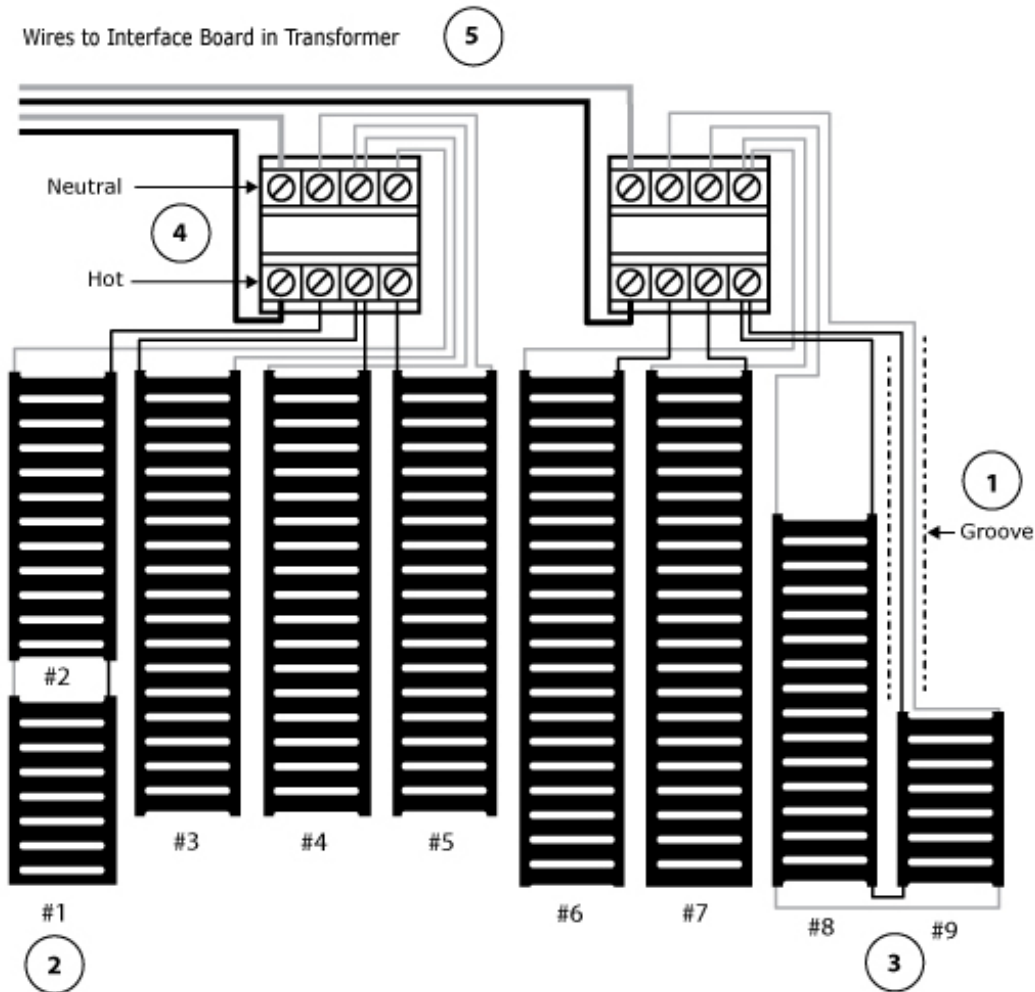

- (1) When running the wires on the floor, route them neatly and do not allow them to cross one another. Where appropriate, make a groove in the floor to protect and bury the wires. Connections and wires can also run under the floor between joists.
- (2) Elements may be linked as long as the added total length does not exceed 450W.
- (3) In some applications, fail safe wiring may be required.
- (4) Terminal block(s) may be needed if the power supply is located away from the elements, as this allows using larger wire gauge to minimize voltage drop. Connect all the <black> wires to one bus-bar and all the <white> wires to the other bus-bar. Maximum total load per terminal block is 450 watts.
- (5) The elements can be routed and connected directly to the interface board on the power supply. Distribute evenly the load from the elements to each circuit breaker.

INSTALLATION

FAIL SAFE WIRING

The Fail Safe Wiring method must be used for installations that are not embedded in concrete, mortar, leveling compound or under underlayment and cement boards, e.g., under carpet and carpet cushion, under the subfloor between joists, in walls, behind mirrors, etc.

Fail Safe Wiring is used wherever there may be a risk of cutting or damaging the bus braids. This method avoids creating a short.

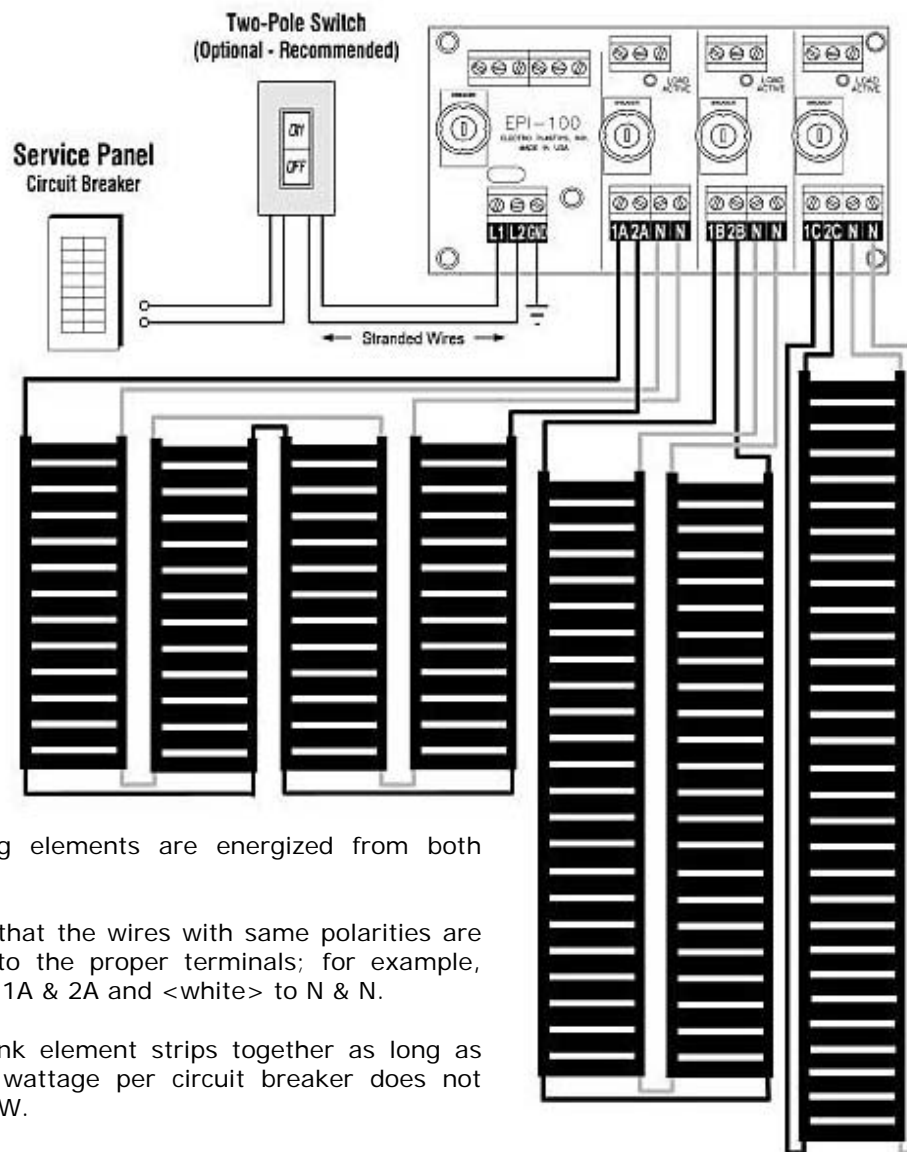

The heating elements are energized from both ends.

Make sure that the wires with same polarities are connected to the proper terminals; for example, <black> to 1A & 2A and <white> to N & N.

You may link element strips together as long as the added wattage per circuit breaker does not exceed 450W.

INSTALLATION

STEP 4 – CONNECTING THE ELEMENTS TO THE POWER SUPPLY

- Each room can have one or more power supplies and if necessary multiple terminal blocks.
- The maximum wattage, on the secondary side, per circuit breaker in the interface board of the power supply is 450 watts (or 18.75 amps on 24V). For example, power supply EPI-LX-R-500W has one circuit breaker with a maximum load of 450W; power supply EPI-LX-R-1000W has two circuit breakers, thereby two times 450W; and power supply EPI-LX-R-1500W has three circuit breakers; thereby three times 450W.
- Minimize voltage drop by planning wire runs as short as possible from elements to power supply. See Wire Gauge Chart for wire size and length versus load.
- If the power supplies are not close to the elements, instead of using larger wire size in the floor, or running too many or too long wires across the room, the elements can be connected to terminal blocks. Keep each terminal block to maximum 450W and then calculate the appropriate wire size used to run to the power supply.
- Always connect elements in parallel - not in series. Connect same polarity wires together and number each element with its corresponding <black> and <white> wires to facilitate further measurements.
- **IMPORTANT:** A certified electrician has to measure the amperage for each heating element BEFORE being covered and the values have to be entered on the Check List form. For guidance, refer to Design & Calculation.
- Select the 24-Volt power supply(s) that has the capacity to satisfy the load of heating elements installed. Maximum load on the power supply is 90% of its total capacity. For data sheet specifications, see Low-voltage Power Supply.
- The power supply must be installed in a well-ventilated area in accordance with Article 450 of the National Electric Code. Provide sufficient clearance for free flow of air to allow adequate cooling and to eliminate risk of overheating. Keep delicate and flammable materials away from the power supply enclosure.
- Choose the appropriate control for the application. For data sheet specifications, see Control Options.
- STEP[®] Labels shall be provided with the heating product. The following labels should be filled out and affixed in the place indicated:
 - Serial Number label comes on the box and/or on the element and on the power supply.
 - The element and the transformer come with a printed or labeled approval mark.
 - Caution label is to be attached to the junction box (if any).
 - Warning label is to be attached to the service panel.
- For the warranty to be valid refer to Terms and Conditions of Sale and Warranty Registration.
- **NOTE:** Leave a copy of all documents referring to the installation of STEP[®] Marine in the service panel on site.

INSTALLATION

STEP 5 – CONNECTING THE POWER SUPPLY AND CONTROLS

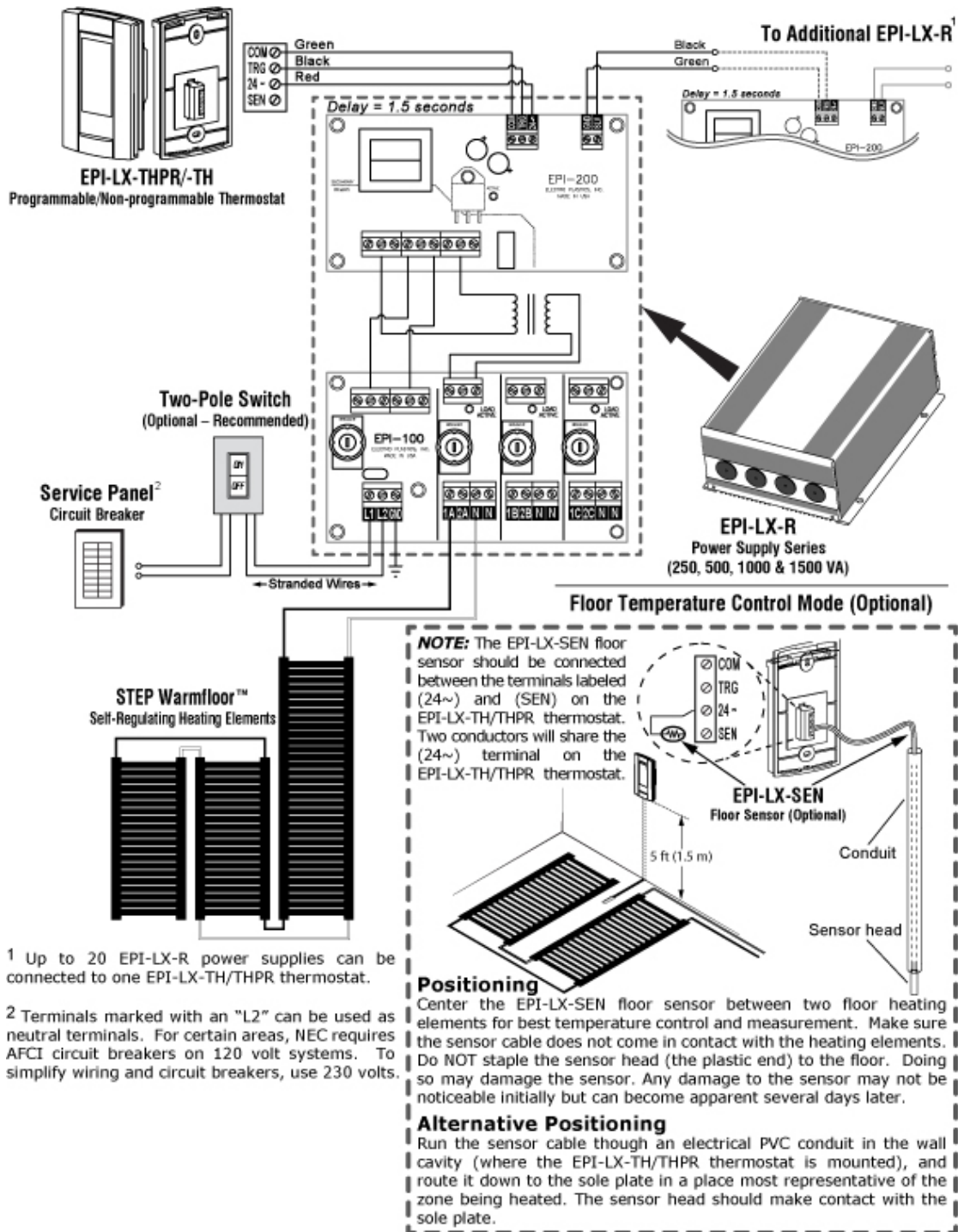

¹ Up to 20 EPI-LX-R power supplies can be connected to one EPI-LX-TH/THPR thermostat.

² Terminals marked with an "L2" can be used as neutral terminals. For certain areas, NEC requires AFCI circuit breakers on 120 volt systems. To simplify wiring and circuit breakers, use 230 volts.

INSTALLATION

WIRING DIAGRAM FOR THE PCB INTERFACE BOARD

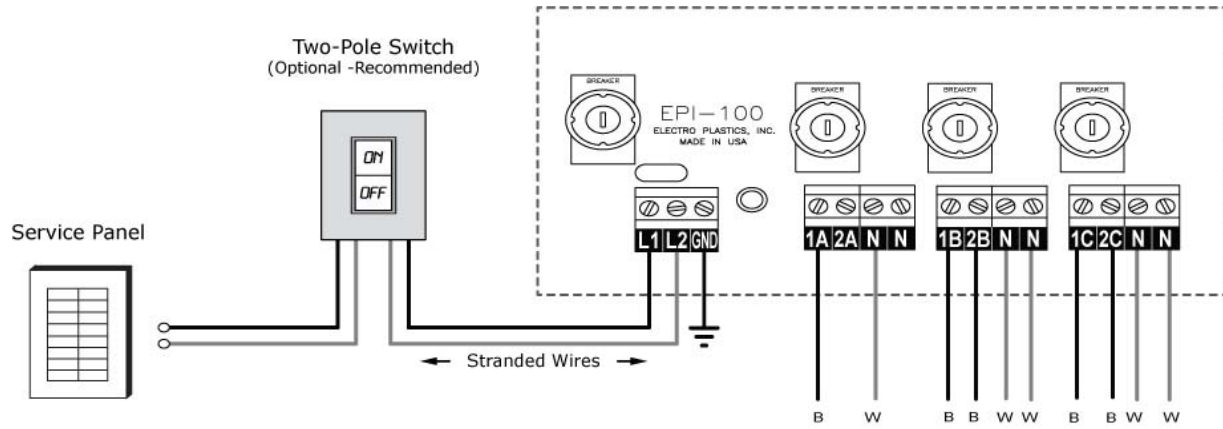

Distribute evenly the load from the elements to each terminal on the secondary circuit breaker. Each terminal can take the following number of wires according to wire gauge:

14 AWG	12 AWG	10 AWG
3	2	1

NOTE: Use only stranded wires in the PCB terminals. Inset wires in a straight (rather than twisted fashion for best contact).

WARNING: Electronics are delicate devices; do not twist or force the terminals and use proper tools to tighten the screws. Tighten with 7 in/Lbf (inch pound force) or 0.8 Nm torque.

PCB EPI-110 and EPI-100 come with one (1) resettable circuit breaker on the primary.

PRIMARY	120 VAC	208 VAC	230 VAC
250W	5A		2.5A
500W	10A	5A	5A
1000W	15A	10A	10A
1500W	20A	15A	15A

PCB EPI-110 has one (1) resettable circuit breaker on the secondary.

SECONDARY	24 VAC
250W	1 x 15A
500W	1 x 25A

PCB EPI-100 can take three (3) resettable circuit breakers on the secondary.

SECONDARY	24 VAC
1000W	2 X 25A
1500W	3 X 25A

INSTALLATION

WIRING DIAGRAM FOR THE PCB REGULATOR BOARD

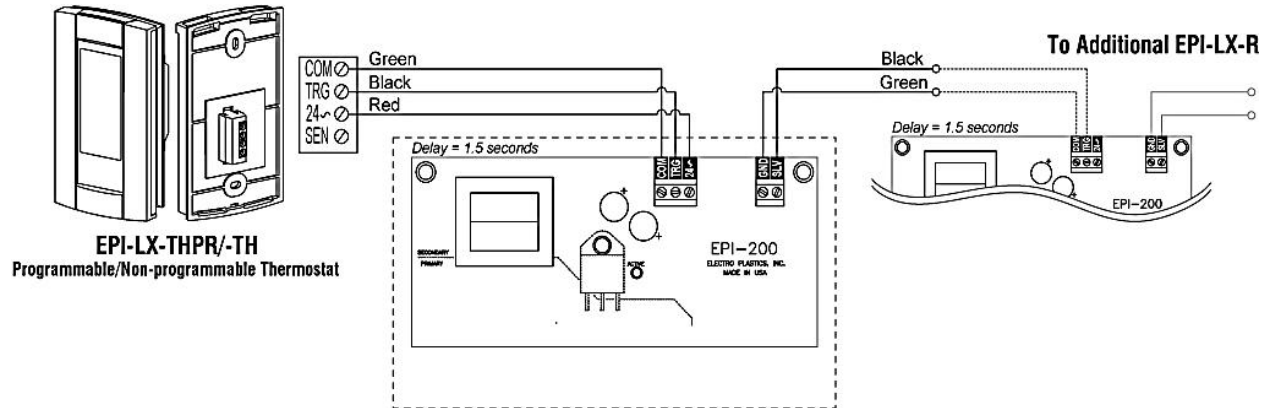

24 VOLTS THERMOSTAT

Use a 3-conductor signal wire (red, green and black) from the PBC EPI-200 to the thermostat.

Up to 20 power supplies can be connected to one control unit with a turn on delay of 1.5 seconds between each power supply.



The thermostat can be used to control the ambient air temperature or the floor temperature.

NOTE: To control the floor temperature an external sensor is required and has to be installed in the floor between and away from the heating element.

As an option for small areas, a line voltage timer switch can control the power supply. Refer to Wiring Diagram for PCB Interface Board.

If a 120V (not available in 230V) line voltage timer switch is going to be used, bypass the thermostatic control by placing a shunt wire between the terminals marked (TRG) and (24~) on the PCB EPI-200.

Switching can also be implemented between these two terminals.

INSTALLATION

STEP 6 – LEVELING AND COVERING THE FLOOR

- Level the floor in accordance with the trade and the manufacturer's instructions, using mortar, mud bed, building boards, underlayment panels, etc. Do not use adhesives or non-approved tapes in direct contact with the elements.
- Codes are revised; new products enter the market and material composition change constantly. It is therefore important to know if these changes comply and/or are compatible with the application.
- Check with the leveling compound and/or building board manufacturer to assure that the material used is appropriate for the given installation.
- To be efficient the heating elements have to be in direct contact with the finished flooring, with no air gaps.
- It is strongly recommended to have thermal insulation under the heating elements.
- Do not place a conductive material in direct contact with the heating elements, i.e., metal mesh, aluminum foil, etc.
- In bathrooms, showers and wet areas, the heating elements shall be installed under a waterproof membrane.
- Respect curing time for concrete, setting materials, grouts and adhesives before turning the heat on.
- To condition the site and acclimatize certain floor coverings, it may be necessary to turn the heating system on. Start with a low heat, and progressively raise the supply temperature until it reaches its maximum temperature.
- The first time the system is switched on; it may take some time until the floor gets to the desired temperature.

WARRANTY REGISTRATION AND COVERAGE

LIMITED WARRANTY:

Electro Plastics' limited warranty is valid from date of original purchase, as follows (not included in this warranty are OEM and specialty products):

- 20 years for the STEP[®] Warmfloor Heating Elements.
- 10 years for the STEP[®] Deicing Heating Elements.
- 10 years for the STEP[®] Transformer Coils in the Power Supplies.
- 3 years for the Interface Electronics in the Power Supplies.
- 3 years for the STEP[®] Controls

Electro Plastics sole obligation under its warranty shall be, at its option, to either issue a credit for the purchase price, or repair or replace any article or part thereof, which is proved to be other than as warranted. For this warranty to be valid, a copy of the STEP[®] Labels shall be delivered to ELECTRO PLASTICS, INC., with a diagram indicating to which branch circuit the system is connected, the location of the element strips, the routing of the wires and their different measurements, voltage, amperage, elements and wire length. Electro Plastics warrants the products to be free from defects in material or manufacturing and to perform under normal use. For the warranty to be valid, qualified personnel who are familiar with the construction and operation of the system must install the equipment and a certified electrician has to verify and measure the STEP[®] elements BEFORE they are covered.

Exclusions

Electro Plastics shall not be responsible for any loss or damage that may arise due to:

- Non-compliance with installation and/or usage of the STEP[®] elements and accessories as recommended. It shall be Buyer's and End User's duty to read and follow carefully the STEP[®] Installation Manual. Technical assistance services, e.g. design and layout are to be used as GUIDELINES ONLY, as each application is specific to local conditions and construction
- Dissatisfaction due to improper Installation of the floor covering. All floor covering shall be installed in conformance with the manufacturer's instructions and shall conform to all applicable trade practices, local codes and manufacturer's specifications.
- Usage of inadequate or non-specified materials with the STEP[®] heating system or products.
- Any and all defects, deficiencies or failures resulting from improper handling of the product; e.g., cuts made to the STEP[®] elements, or the wires, etc.
- Tampering with the STEP[®] heating system or products; e.g., removing, altering or overloading the circuit breakers, overcurrent protectors, etc.
- Installation of merchandise with obvious visible defects.

How to claim this warranty

In order to obtain warranty service, Buyer shall return the unit to the dealer from whom the unit was originally purchased, with a dated sales receipt. The dealer will forward the unit to Electro Plastics. Upon receipt of the defective unit, paperwork and explanation of application, Electro Plastics will inspect and test the unit in order to determine the reason for the alleged failure. If it is determined that the unit was properly installed and failed during normal use, as a result of a manufacturing defect, Electro Plastic will repair or replace the unit, or issue a credit or refund of the purchase price, at its sole discretion. The warranty period for any replacement unit will fulfill the warranty of the original unit and will not be extended.

WARRANTY REGISTRATION AND COVERAGE

Limitations

Under no circumstances will Electro Plastics be liable for labor or other charges related to the installation and use of the STEP® heating system or products. This warranty does not cover labor or removal or reinstallation of the product and is void on any product installed improperly, or in an improper environment, overloaded, misused, abused or altered in any manner. THE WARRANTIES STATED HEREIN ARE EXCLUSIVE OF ALL OTHER WARRANTIES, WRITTEN OR ORAL, STATUTORY EXPRESS OR IMPLIED, INCLUDING ANY WARRANTIES OF MERCHANTABILITY AND FITNESS FOR A PARTICULAR PURPOSE, NONE OF WHICH SHALL APPLY TO THE SALE OF THE COMPANY'S PRODUCTS HEREUNDER. THIS WARRANTY ALSO EXCLUDES INCIDENTAL OR CONSEQUENTIAL DAMAGES FOR BREACH OF ANY WARRANTY ON THE PRODUCTS. Products which are replaced by Electro Plastics in accordance with the foregoing shall become the property of Electro Plastics and shall be returned to it by the purchaser f.o.b. point of shipment. The maximum liability of this warranty is limited to the replacement or repair or purchase price of the defective unit. If a unit is returned and found that no defect exists, or that the user misused the unit, Electro Plastics will inform the user. If the user chooses to have the unit repaired (if possible), labor and shipping charges will apply.

Limitation of Liability

ELECTRO PLASTICS SHALL NOT BE LIABLE FOR ANY LOSS, CLAIM, EXPENSE OR DAMAGE CAUSED BY, CONTRIBUTED TO OR ARISING OUT OF THE ACTS OR OMISSIONS OF BUYER OR THIRD PARTIES, WHETHER NEGLIGENT OR OTHERWISE, IN NO EVENT SHALL ELECTRO PLASTICS' LIABILITY FOR ANY CAUSE OF ACTION WHATSOEVER EXCEED THE COST OF THE PRODUCT GIVING RISE TO THE CLAIM, WHETHER BASED IN CONTRACT, WARRANTY, INDEMNITY OR TORT (INCLUDING NEGLIGENCE AND STRICT LIABILITY) OR OTHERWISE. IN NO EVENT SHALL ELECTRO PLASTICS BE LIABLE OR ANY SPECIAL, INCIDENTAL, CONSEQUENTIAL OR OTHER SUCH INDIRECT DAMAGES (INCLUDING, WITH-OUT LIMITATION, LOSS OF REVENUES, PROFITS OR OPPORTUNITIES), WHETHER ARISING OUT OF OR AS A RESULT OF BREACH OF CONTRACT, WARRANTY, TORT (INCLUDING NEGLIGENCE), STRICT LIABILITY OR OTHERWISE.

WARRANTY REGISTRATION CARD

Ref. No.

CUSTOMER INFORMATION

Owner's Name

Address

City / State / Zip

Phone

Email

PURCHASE AND PROJECT INFORMATION

Purchased From

Date

Address

Product Purchased: Floor Heating
 Snowmelt
 Deicing

Heating Elements Bathroom Galley
 Installed in : Lounge Other

Heating Elements Tile/Stone Carpet
 Installed under: Hardwood Laminate
 Between frames Other

Type of Project: New Construction
 Renovation

To activate warranty complete and return this warranty registration card signed with a complete checklist and layout showing element distribution as installed to: 11147 Dorsett Road, Maryland Heights, MO 63043, U.S.A.



WARRANTY REGISTRATION AND COVERAGE

CHECK LIST

Ref. No. Page of.....

Thermostat Model No.: STEP® Touch EPI-LX-TC-24V	Heating Element Model No. : STEP® Element MEP-.....-.....W-24V	Total Length Installed : Linear Feet
Sensor Model No.: <input type="checkbox"/> EPI-LX-TS	Transformer Model No. : <input type="checkbox"/> 120V EPI-LX-...-.....W <input type="checkbox"/> 208V <input type="checkbox"/> 230V	DC Controller Model No.: <input type="checkbox"/> 24V EPI-LX-DC-.....W <input type="checkbox"/> Other

MEASUREMENT INSTRUCTIONS

Measure primary and secondary volts and amps at the terminals. One sheet per transformer or DC Controller. Please fill in the electrical values in the boxes below.

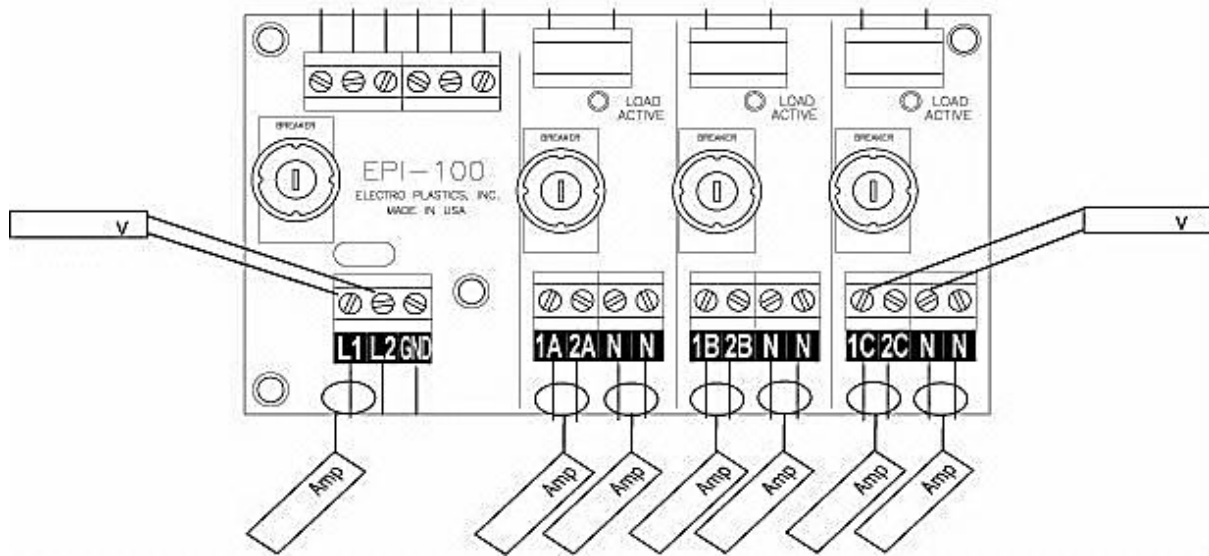

Installed / measured by:

Date:

Name

Signature

TROUBLESHOOTING

If the following procedures do not solve and relieve the problems encountered, please check with our Technical Service Department.

A. POWER SUPPLY

Problem:

Solution:

1. Power Supply/DC Controller will not start:

a) No current

- Reset circuit breaker in service panel and switch on line voltage branch circuit.

b) Current is present

- Reset mini circuit breaker in power supply, push plunger in until it stays in.

c) PC board in AC Power Supply / DC Controller has current

- Make sure the thermostat settings are correct and that the thermostat calls for heat. Set the temperature to maximum and wait a couple of minutes for the system to turn on.
- If this does not work, eliminate thermostat; disconnect thermostat cable from PCB (printed circuit board) and put a jump wire from terminal TRG to 24. The load active should now be lighted and the system is on. The fault is in the thermostat cable or its connections.

2. Power Supply becomes hot:

a) Poor ventilation

- Power Supply should be mounted vertical for the cooling fins to extract heat from the enclosure and it must be placed in a well-ventilated area.

b) High voltage conditions

- A service technician can rewire Power Supply to accept higher voltage. Call customer service for guidance.

c) High ambient temperature

- Power supply must be de-rated; decrease load.

TROUBLESHOOTING

B. HEATING ELEMENTS

Problem:

Solution:

1. Insufficient temperature:

a) Thermostat setting

- Set temperature to desired level and leave it on day and night. This is the best energy saving mode. Temperature will build up in walls, floor and ceiling and the self-regulating heating elements will effortlessly maintain a warm comfortable environment.

b) Cold spots in the floor

- The most common cause is lack of insulation, humid or wet insulation or an air gap between flooring layers.
- Cold strips are noticed between elements also if they are spaced out too far.

c) Hot spots in the floor

- Hot water tubing and hot air ducts, etc., would contribute to hot spots. STEP[®] heating elements are self-regulating and cannot overheat by themselves.

d) Low supply voltage

- Some regions or locations may have a low supply voltage and some may take electricity from sub-panels with reduced voltage. This results in a proportionally lower heat output. It is possible to boost up the voltage so the elements can pull more amps but this requires engineering.

